

Esquema del curs

SECTOR
REAL

SECTOR
FINANCER

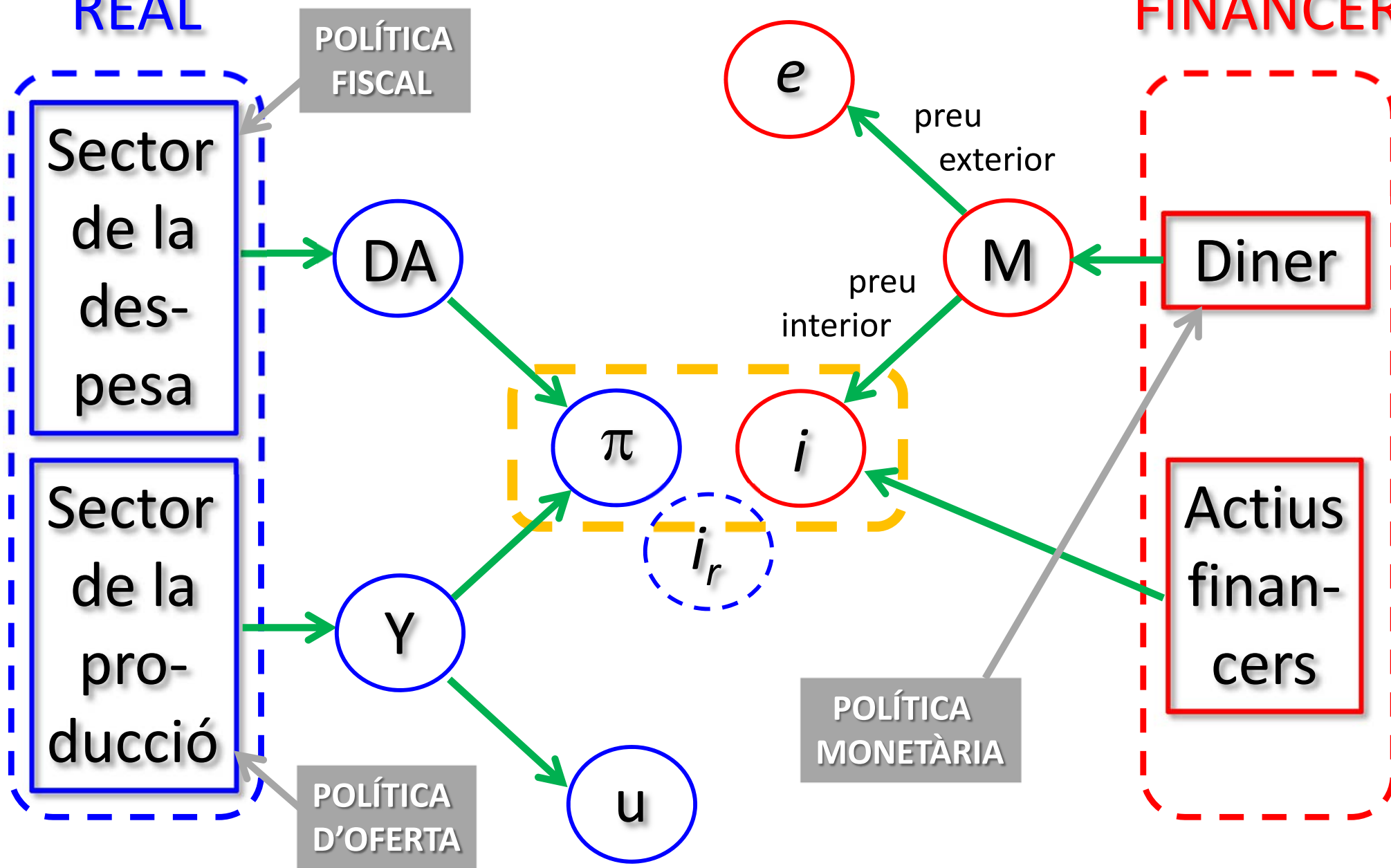

Esquema del curs

SECTOR
REAL

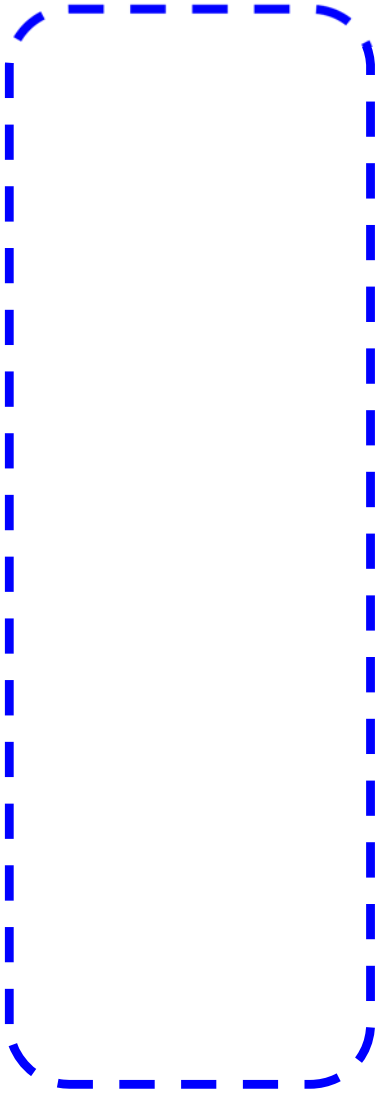

Esquema del curs

SECTOR
REAL

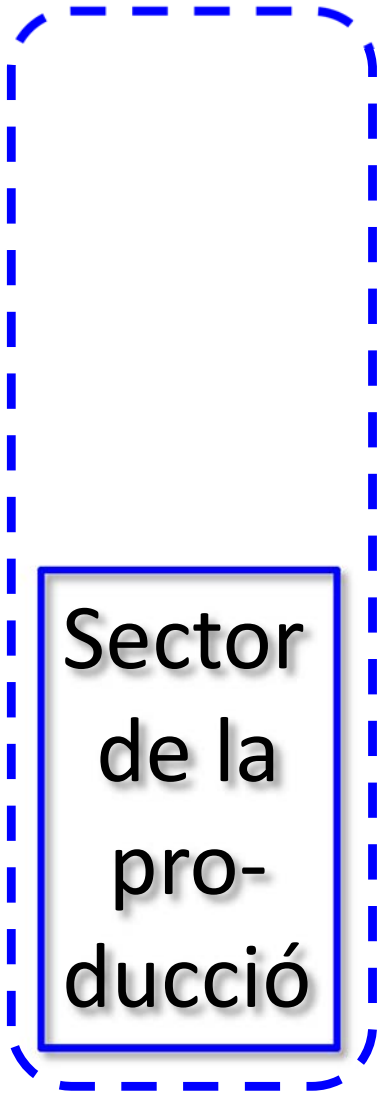

Sector
de la
pro-
ducció

Esquema del curs

SECTOR
REAL

Sector
de la
des-
pesa

Sector
de la
pro-
ducció

Esquema del curs

SECTOR
REAL

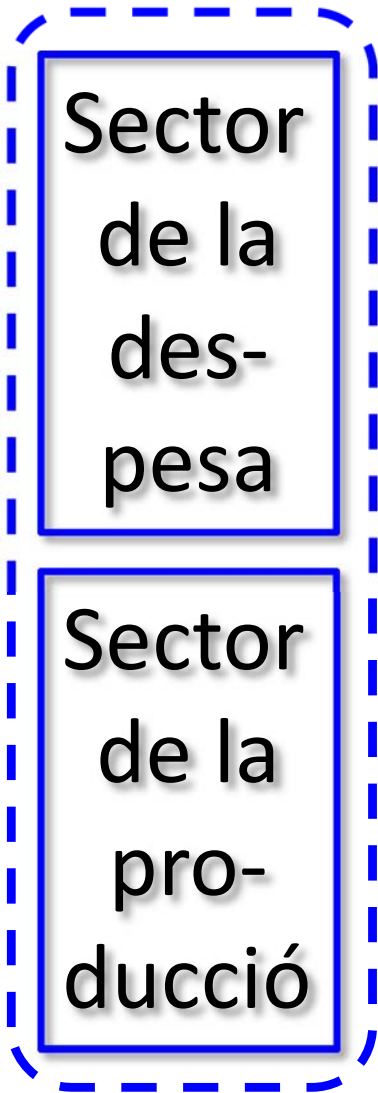

SECTOR
FINANCER

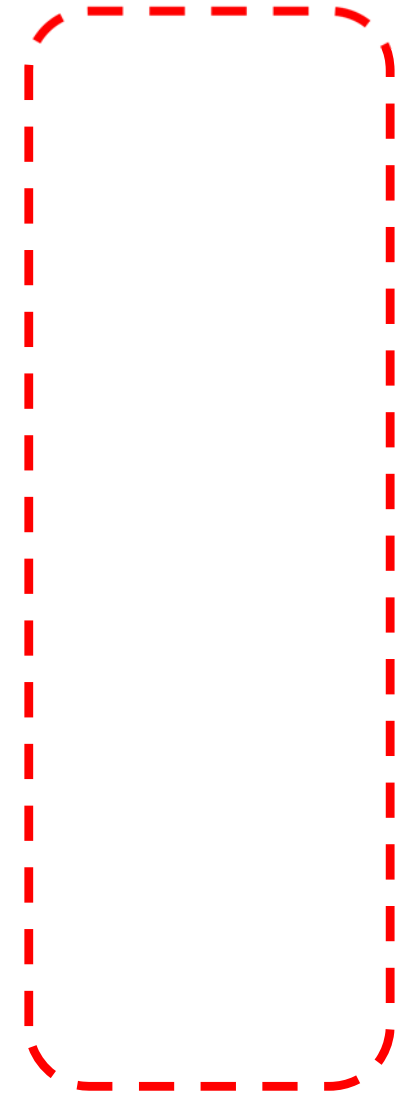

Esquema del curs

SECTOR
REAL

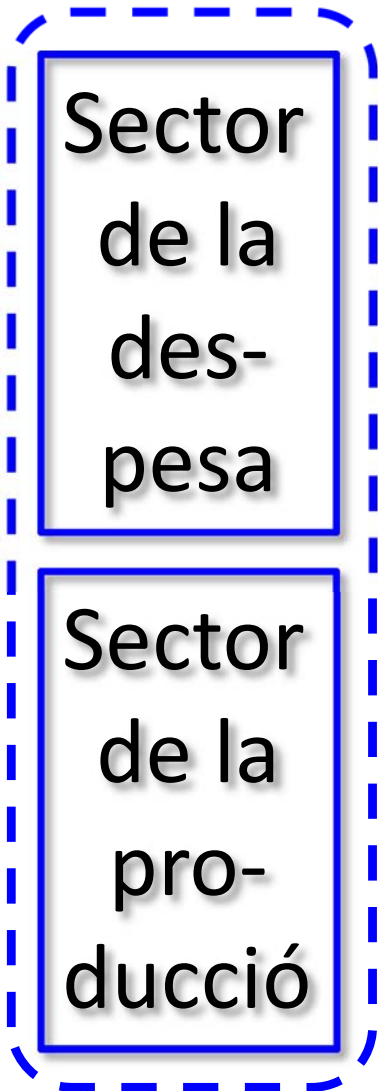

SECTOR
FINANCER

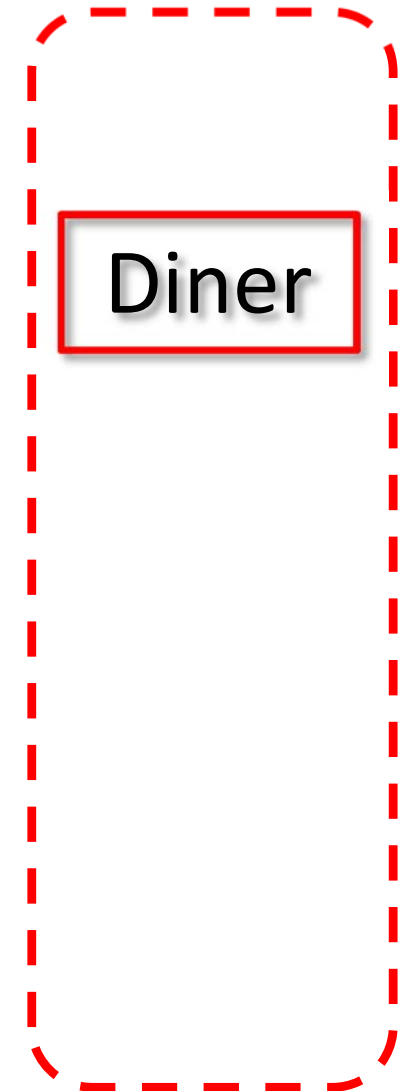

Esquema del curs

SECTOR REAL

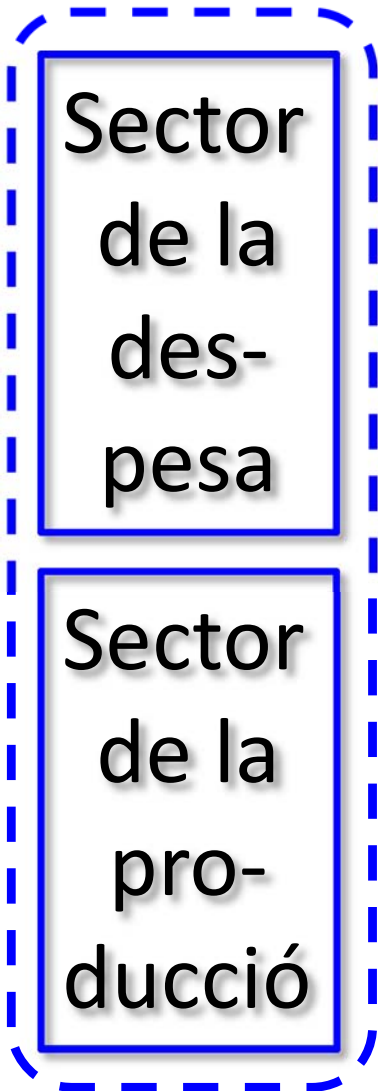

SECTOR FINANCER

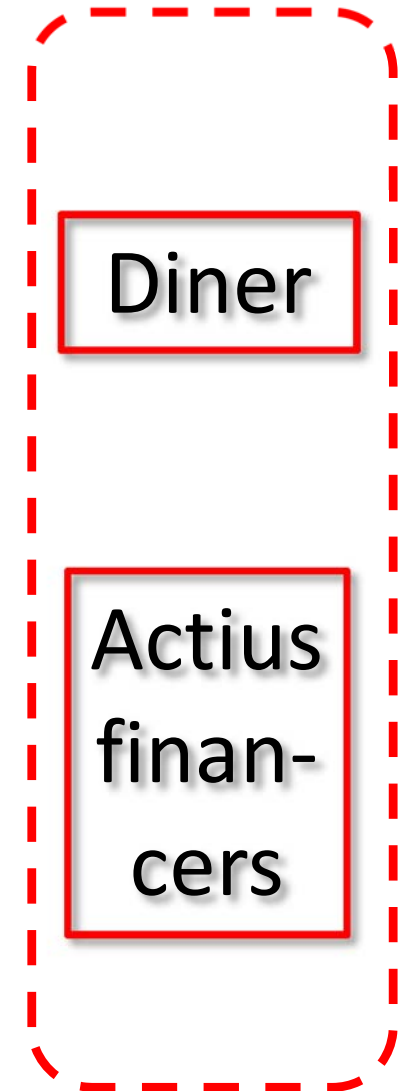

Esquema del curs

SECTOR
REAL

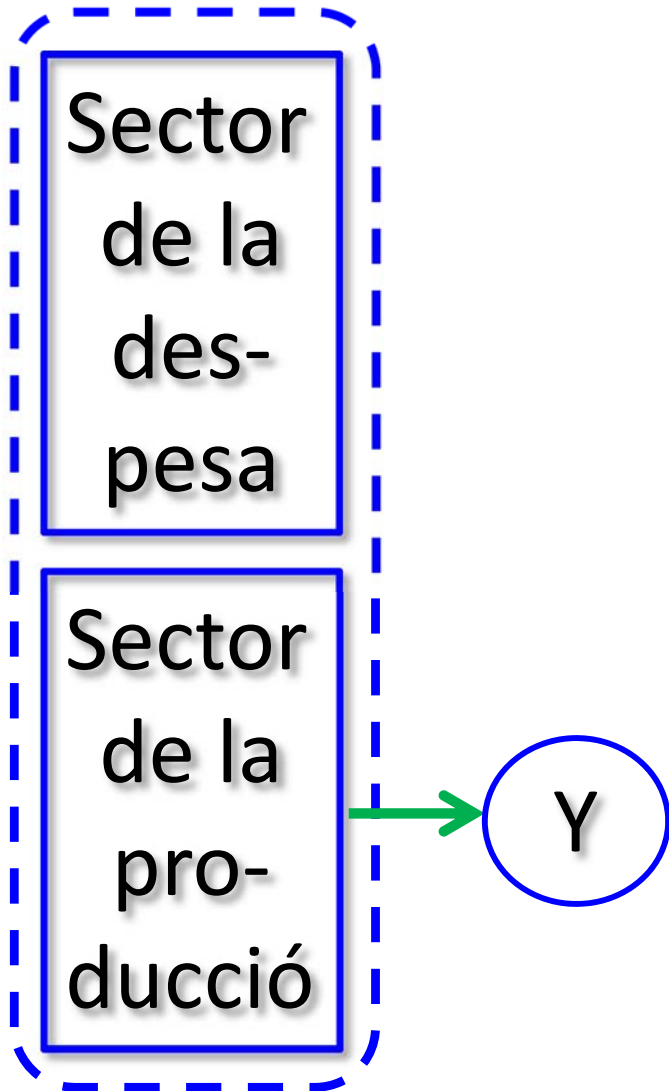

SECTOR
FINANCER

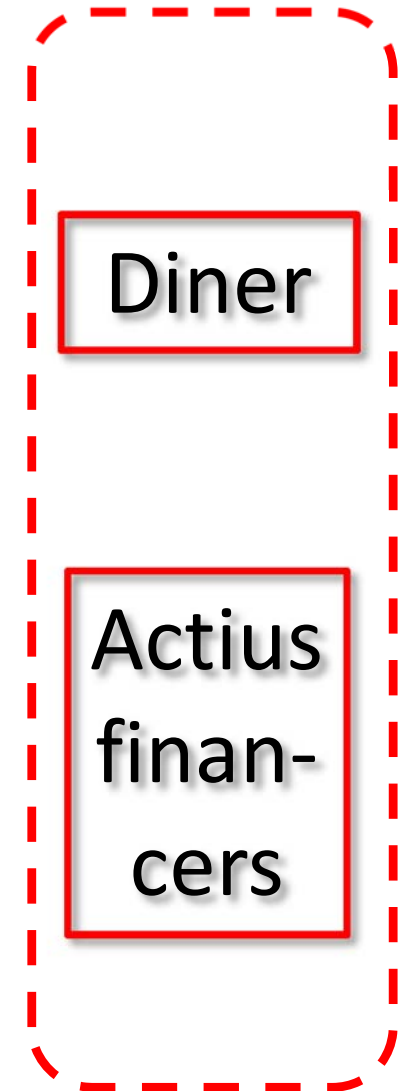

Esquema del curs

SECTOR
REAL

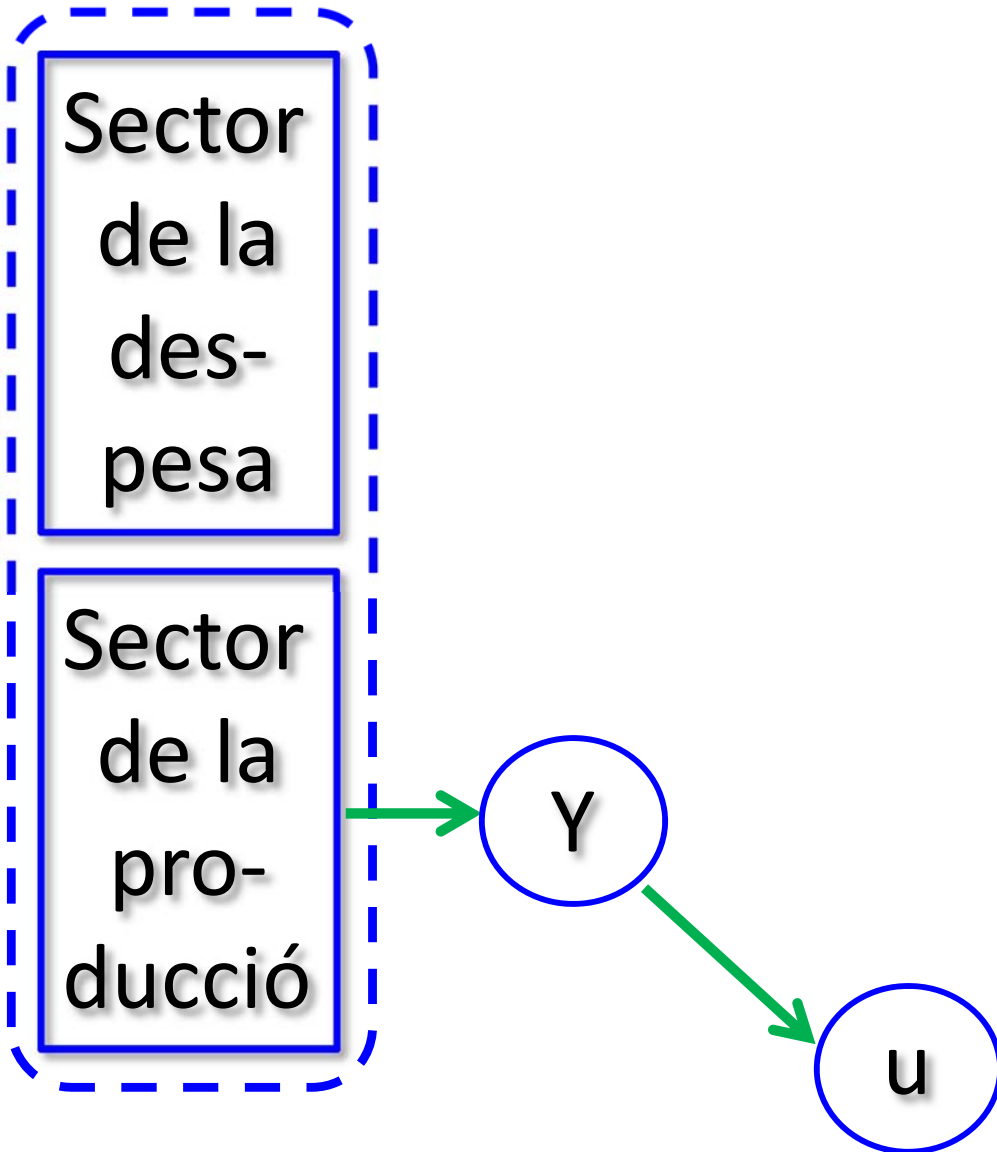

SECTOR
FINANCER

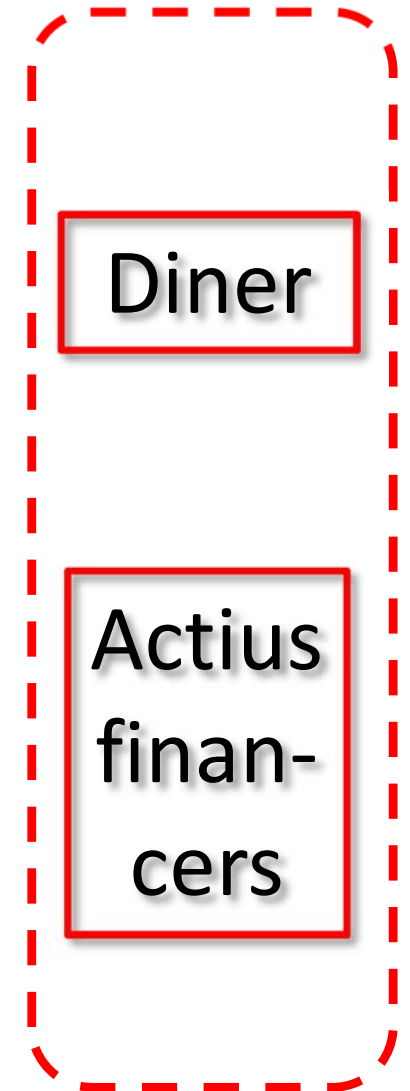

Esquema del curs

SECTOR
REAL

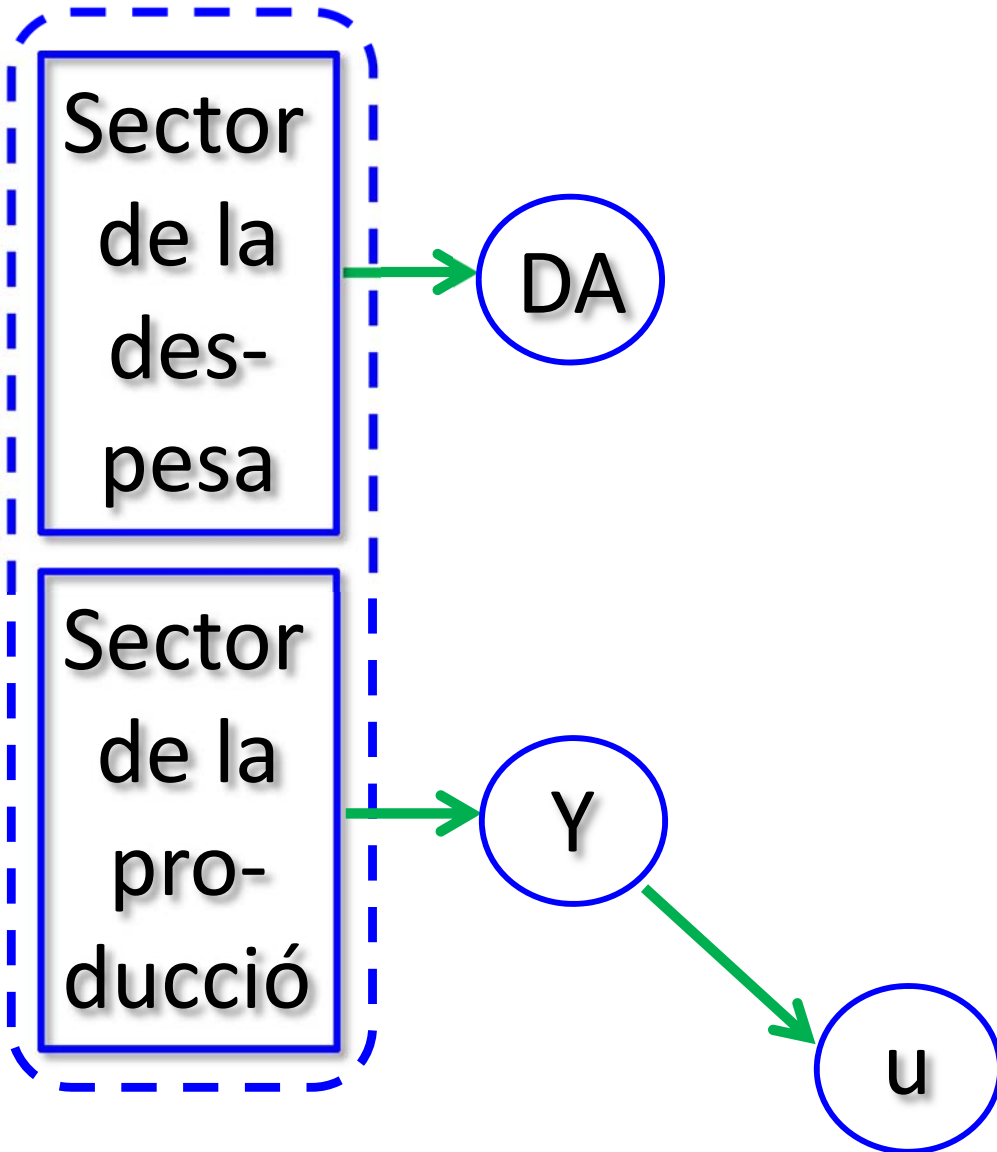

SECTOR
FINANCER

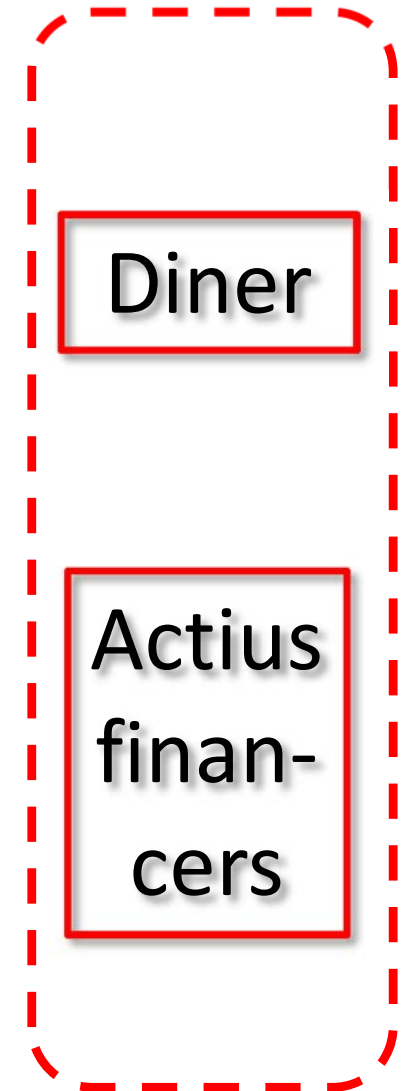

Esquema del curs

SECTOR
REAL

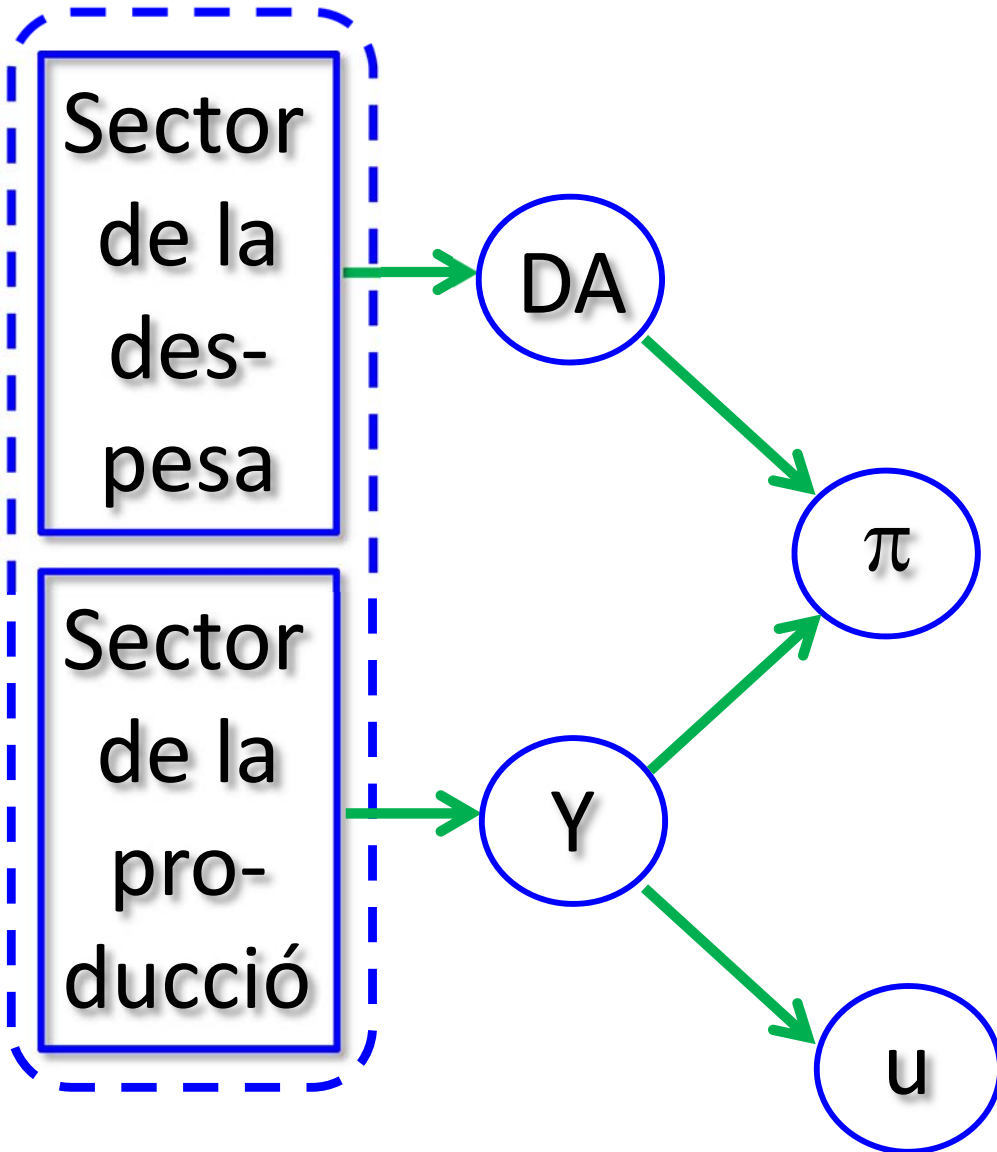

SECTOR
FINANCER

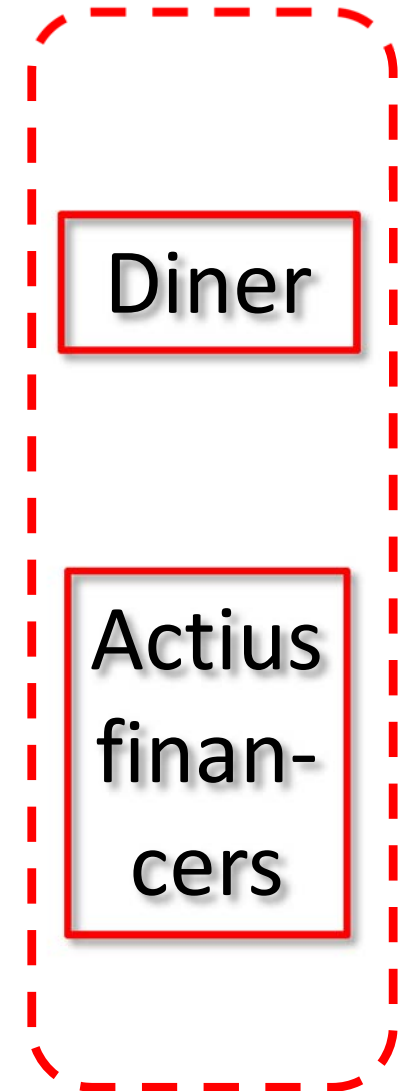

Esquema del curs

SECTOR
REAL

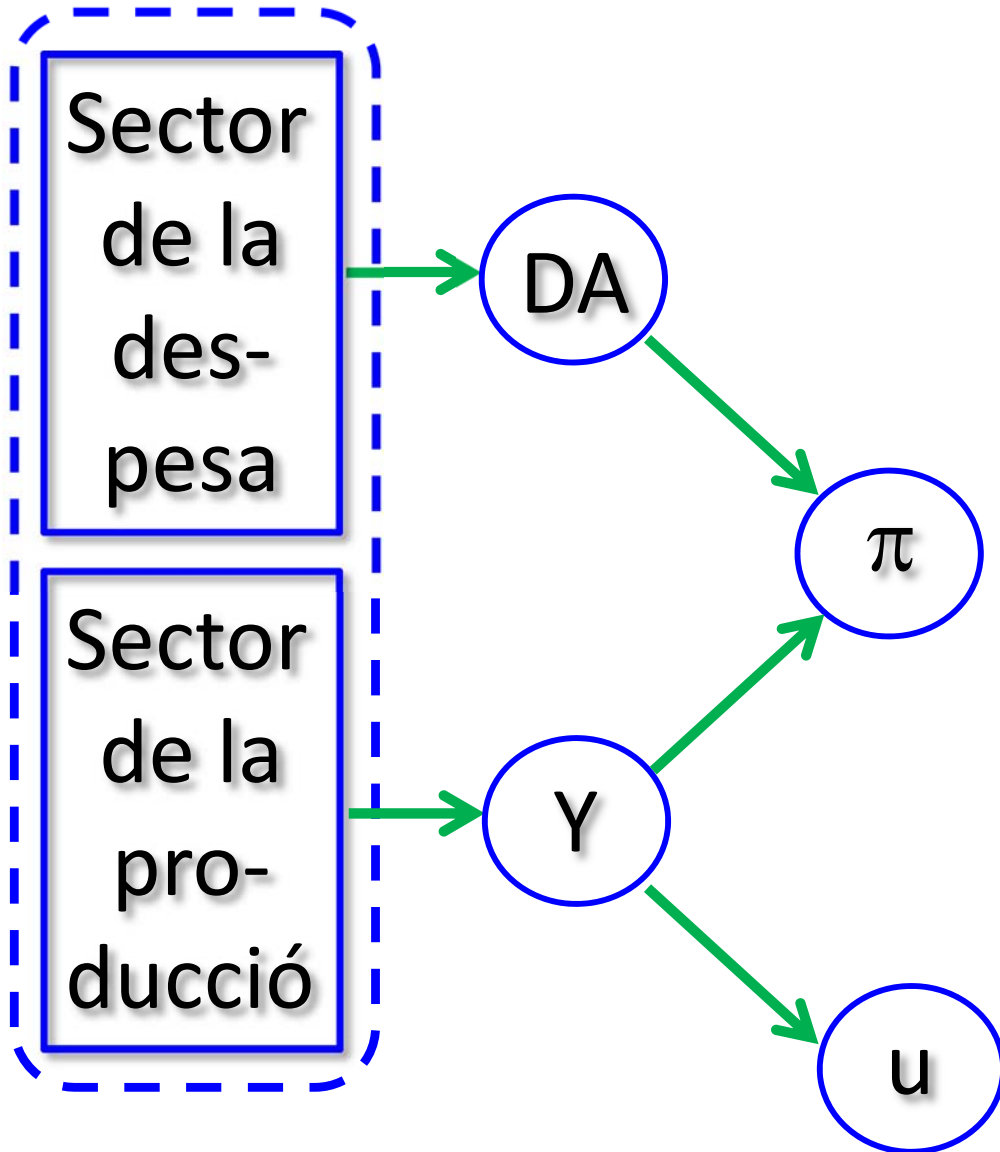

SECTOR
FINANCER

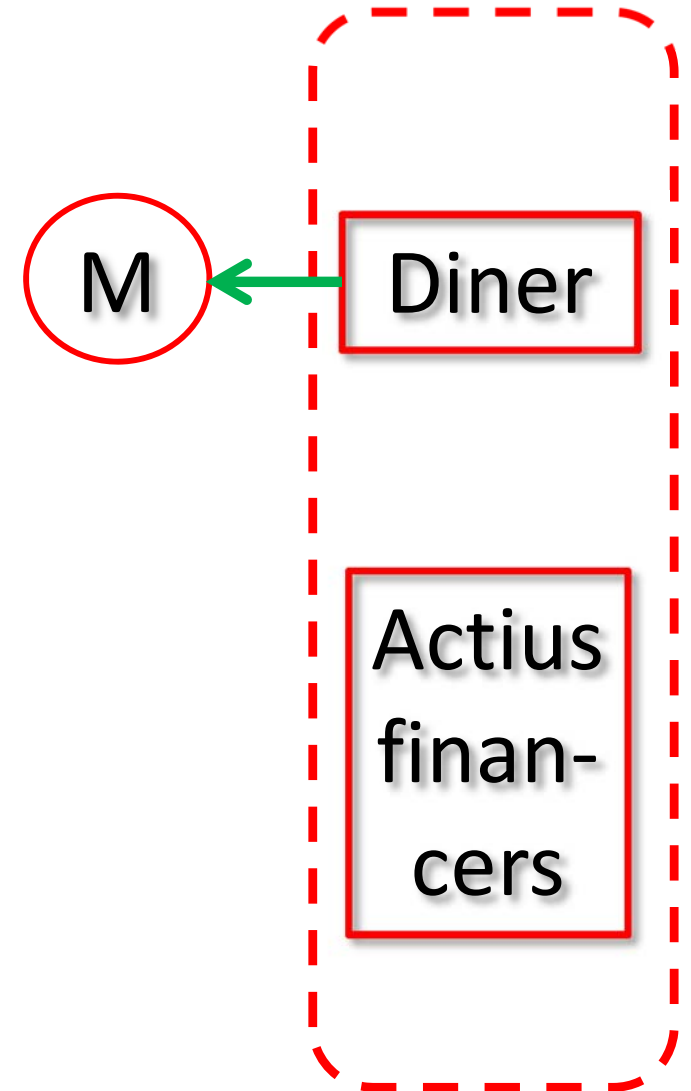

Esquema del curs

SECTOR
REAL

SECTOR
FINANCER

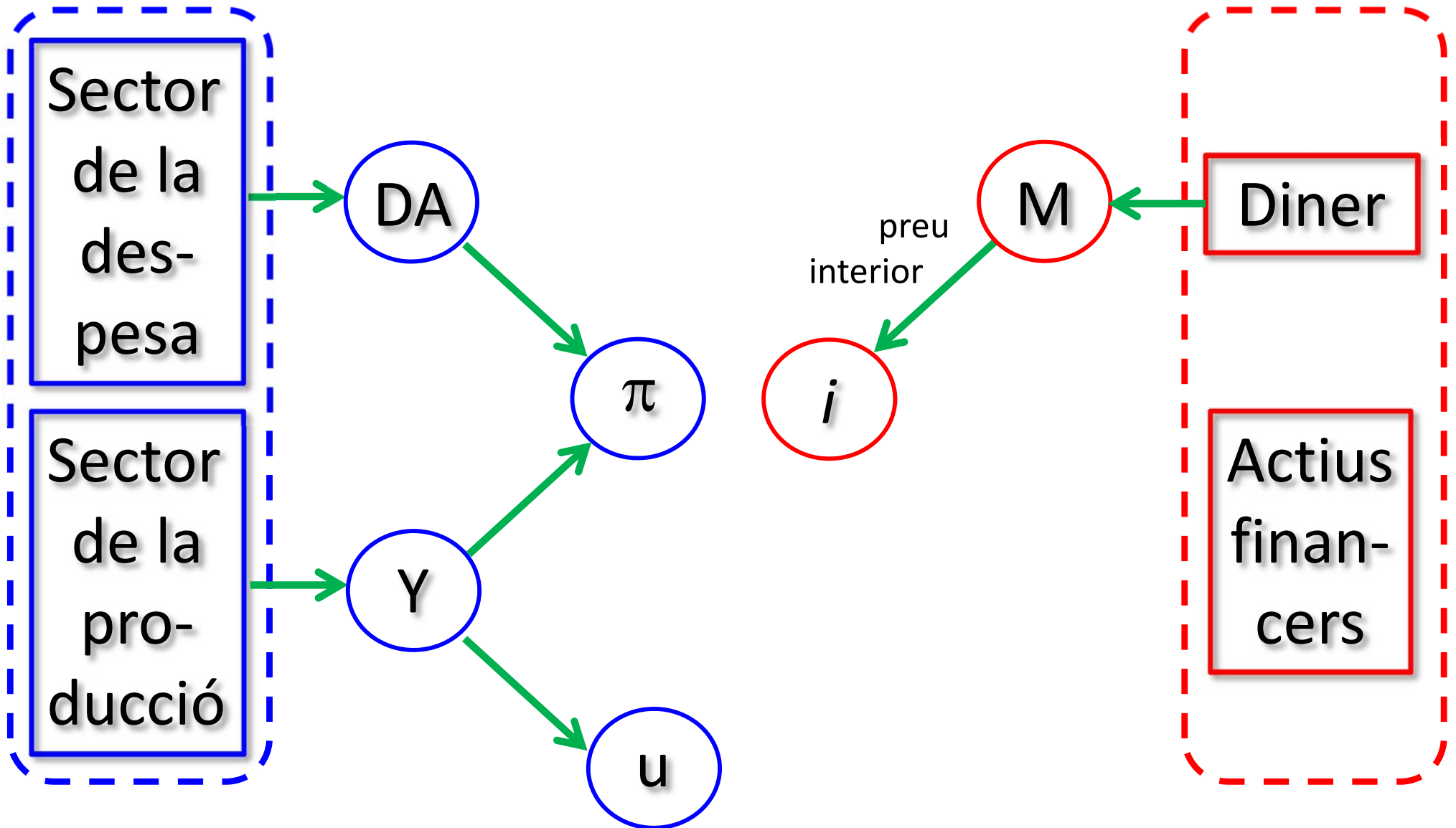

Esquema del curs

SECTOR
REAL

SECTOR
FINANCER

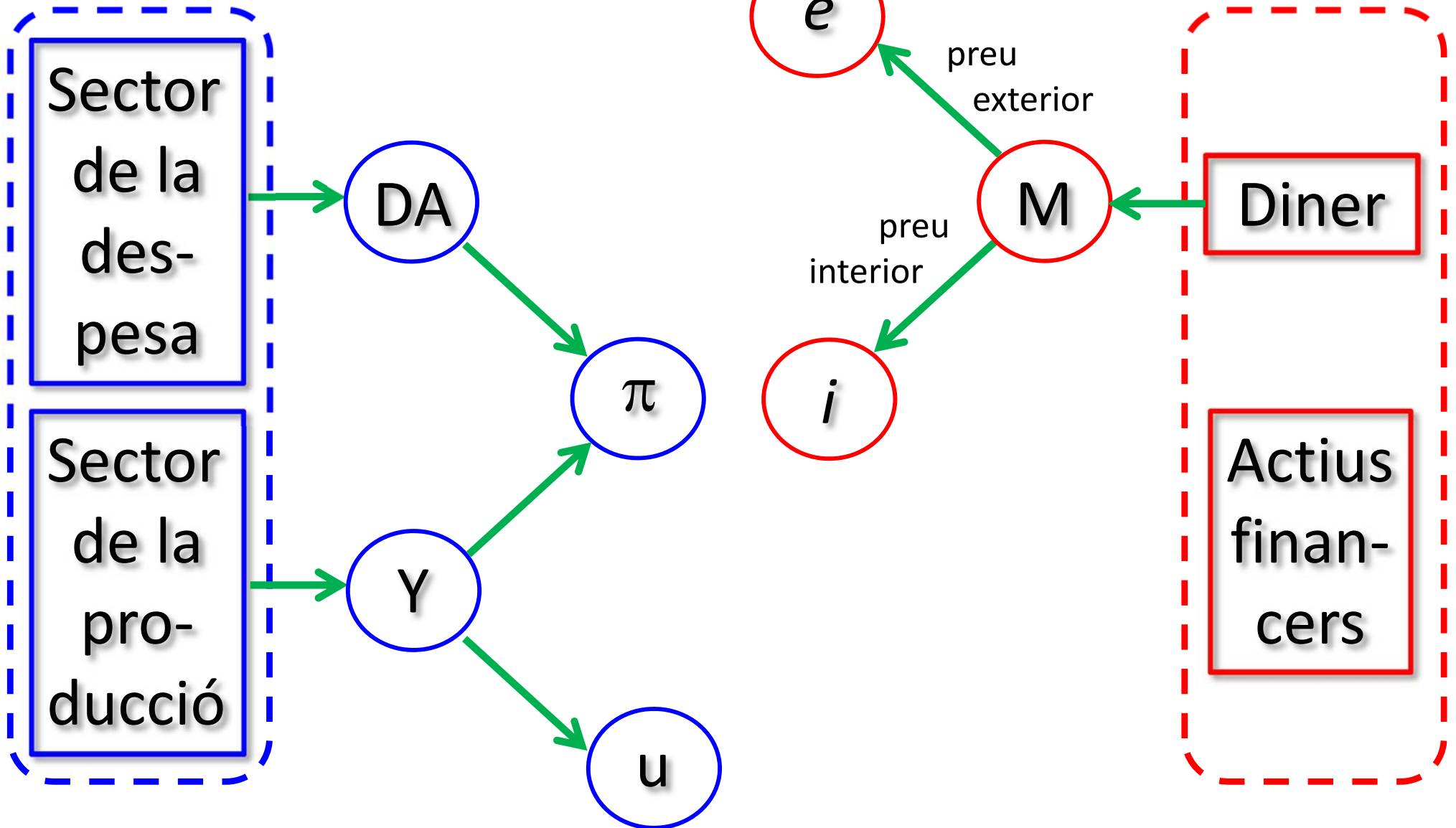

Esquema del curs

SECTOR
REAL

SECTOR
FINANCER

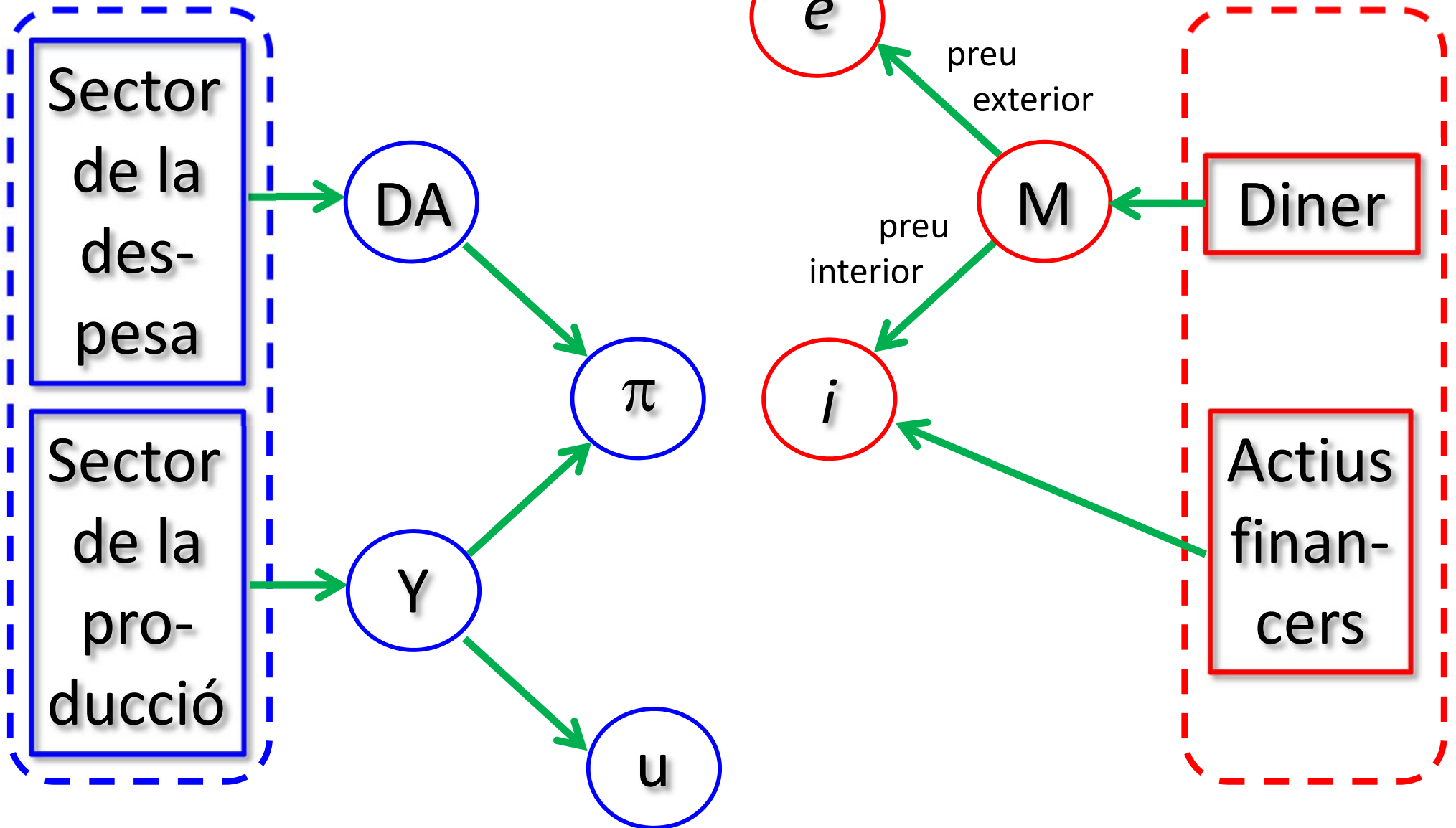

Esquema del curs

SECTOR
REAL

SECTOR
FINANCER

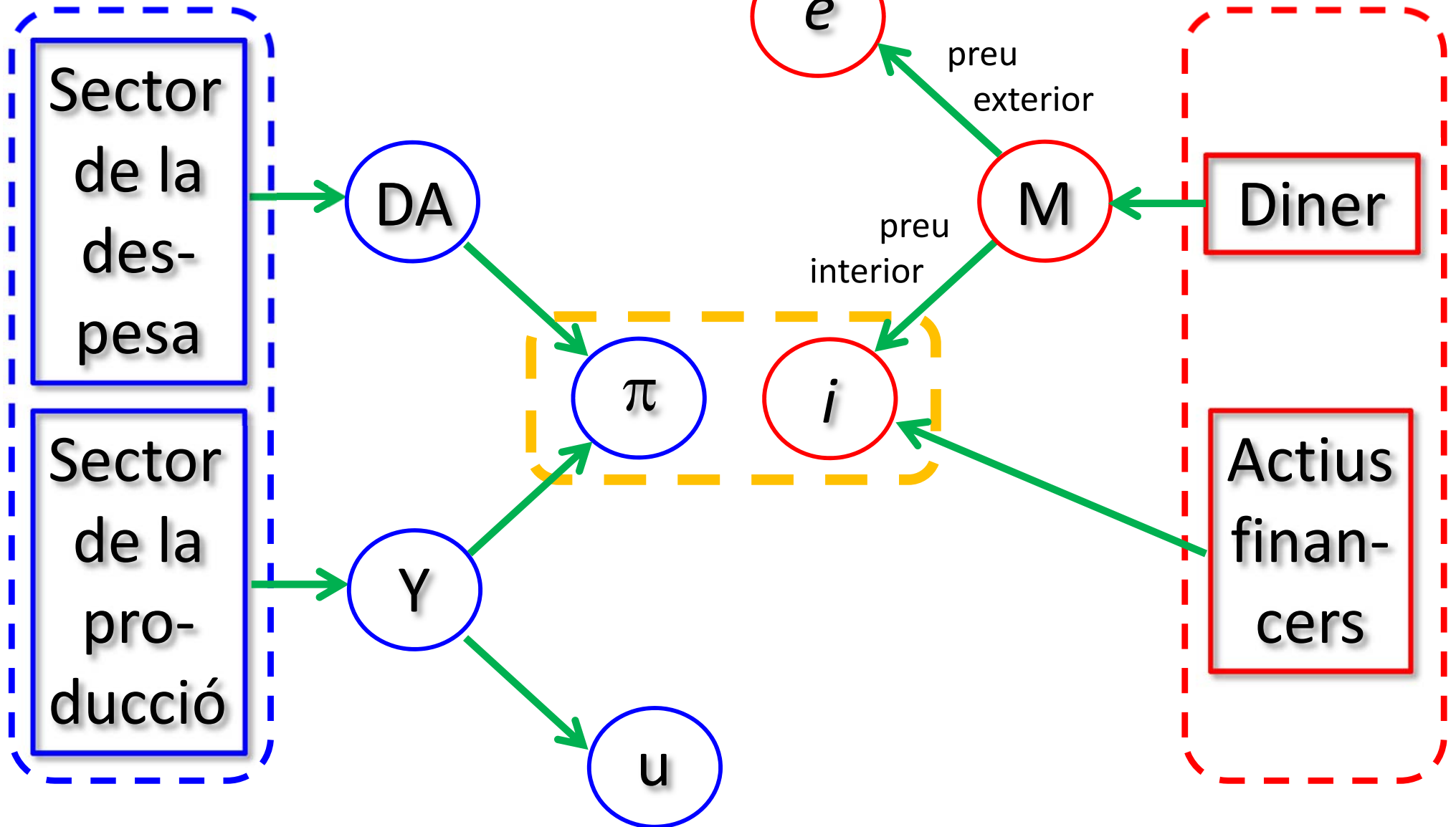

Esquema del curs

SECTOR
REAL

SECTOR
FINANCER

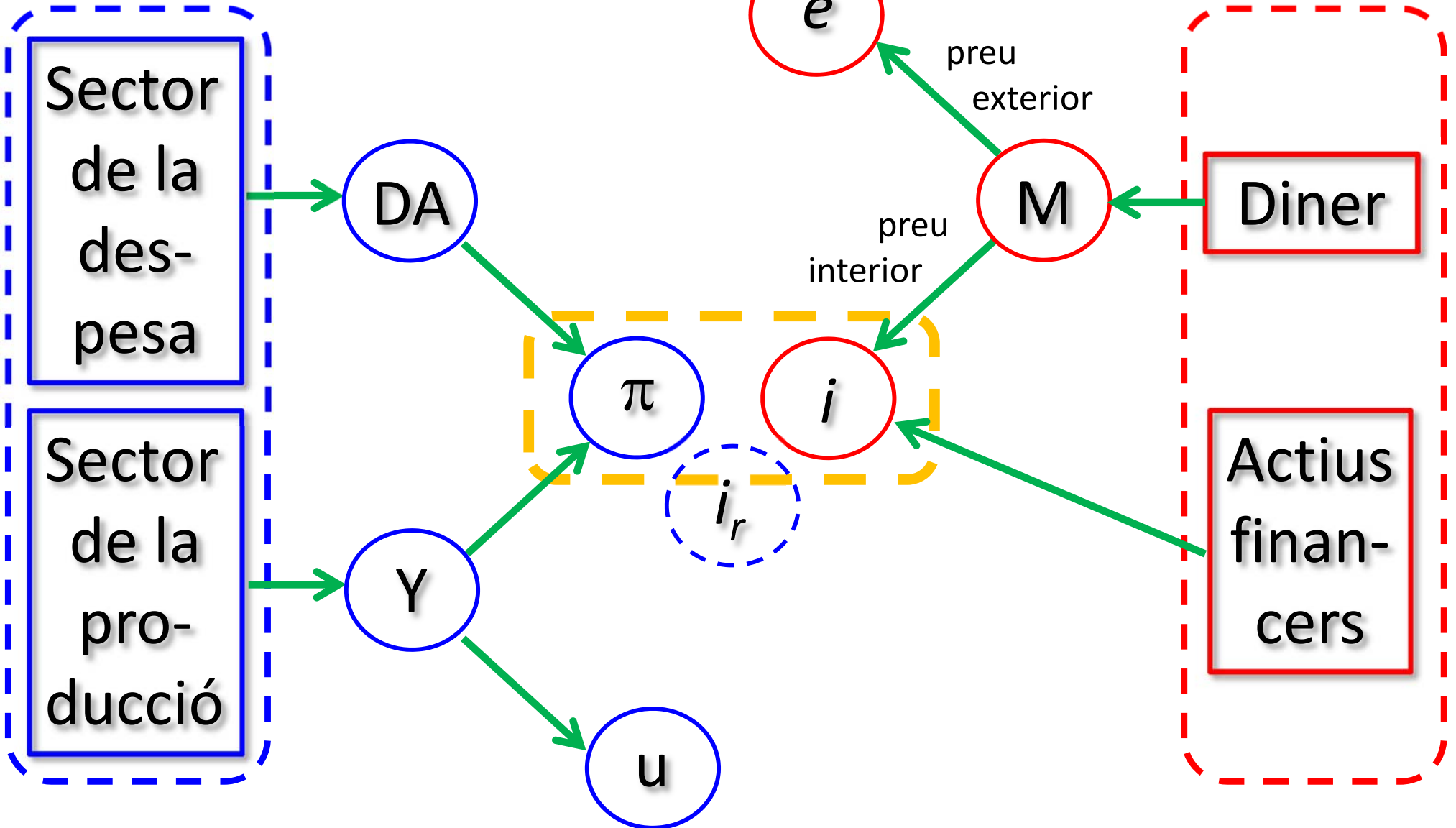

Esquema del curs

SECTOR
REAL

SECTOR
FINANCER

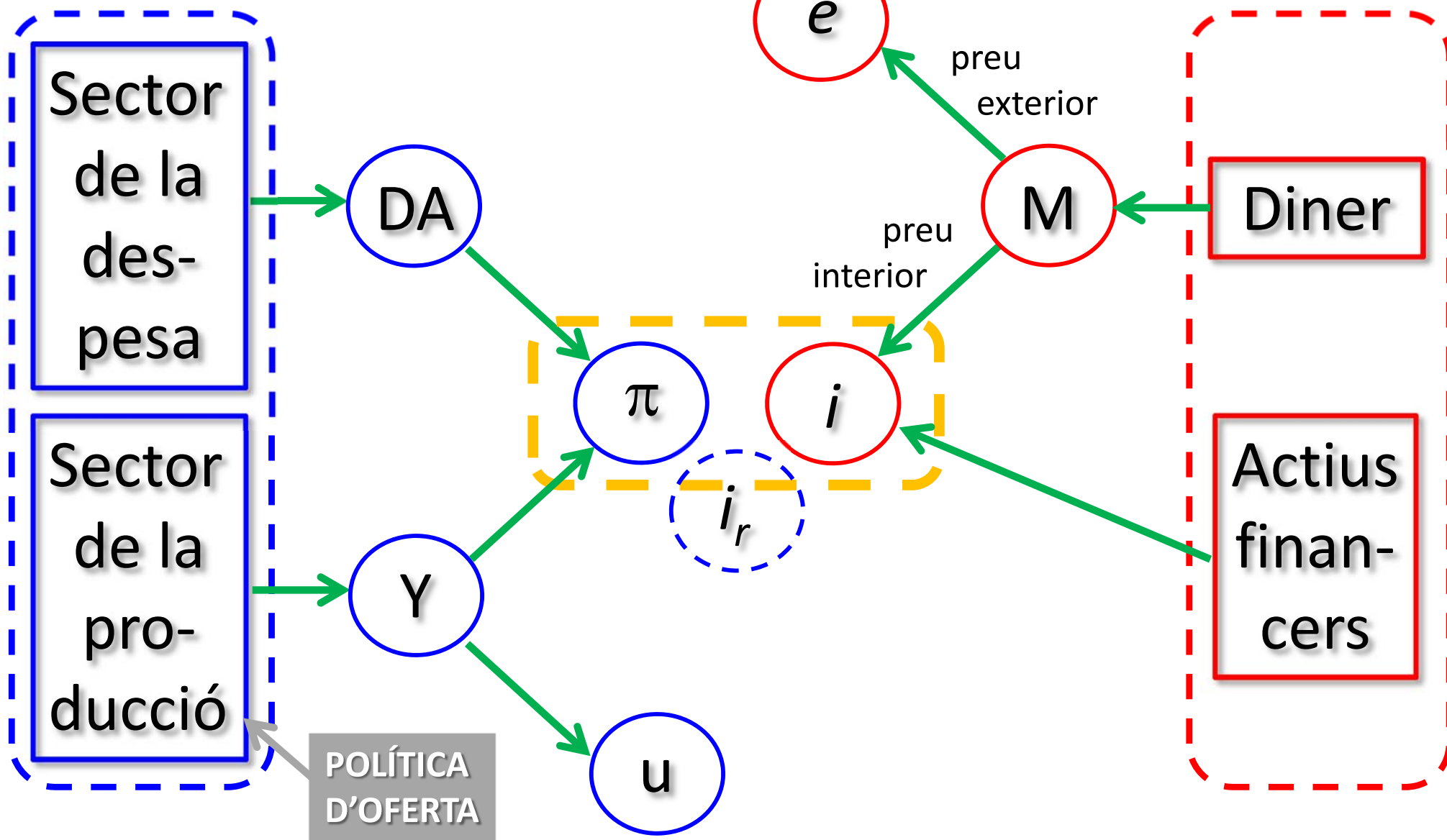

Esquema del curs

SECTOR
REAL

SECTOR
FINANCER

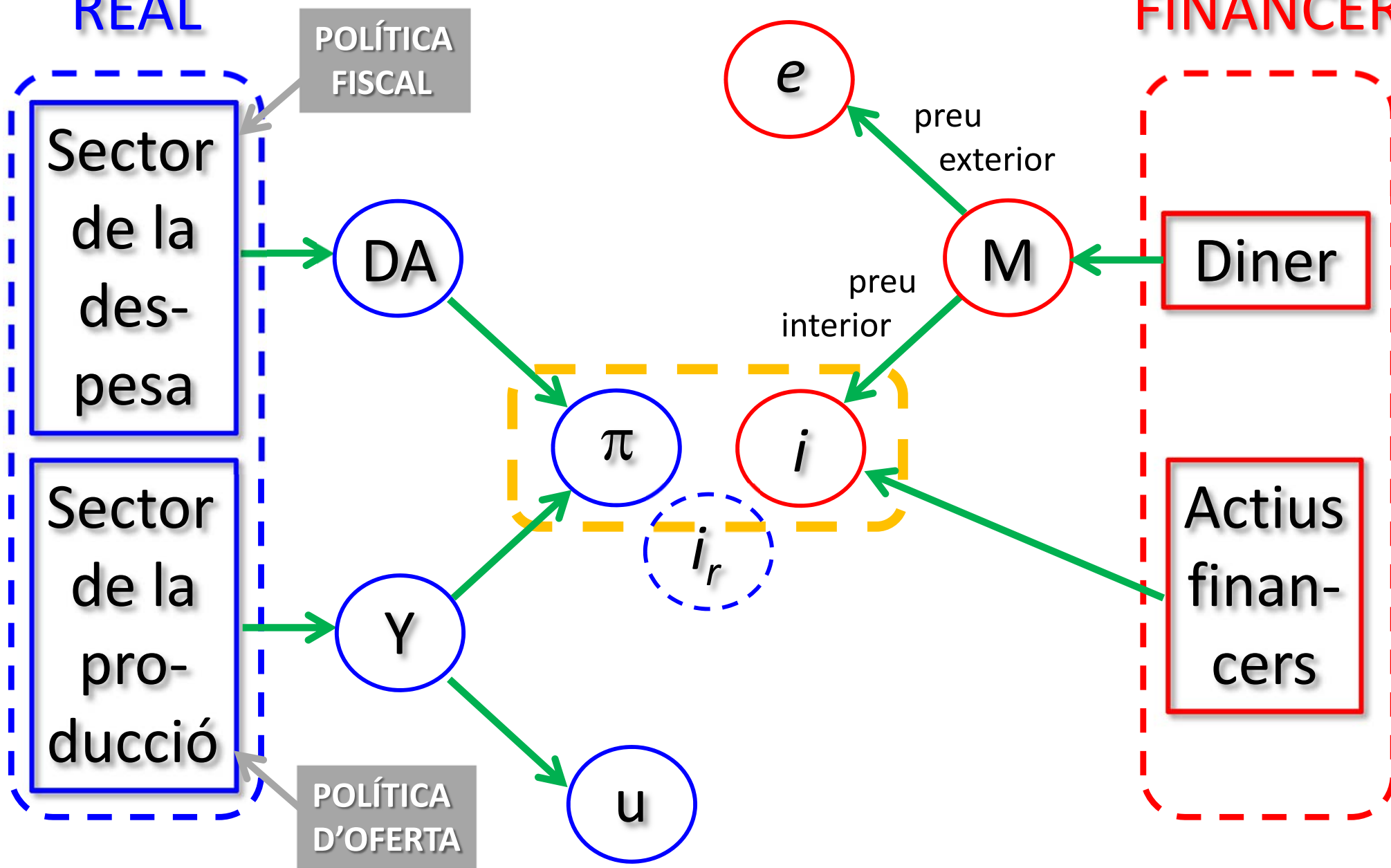

Esquema del curs

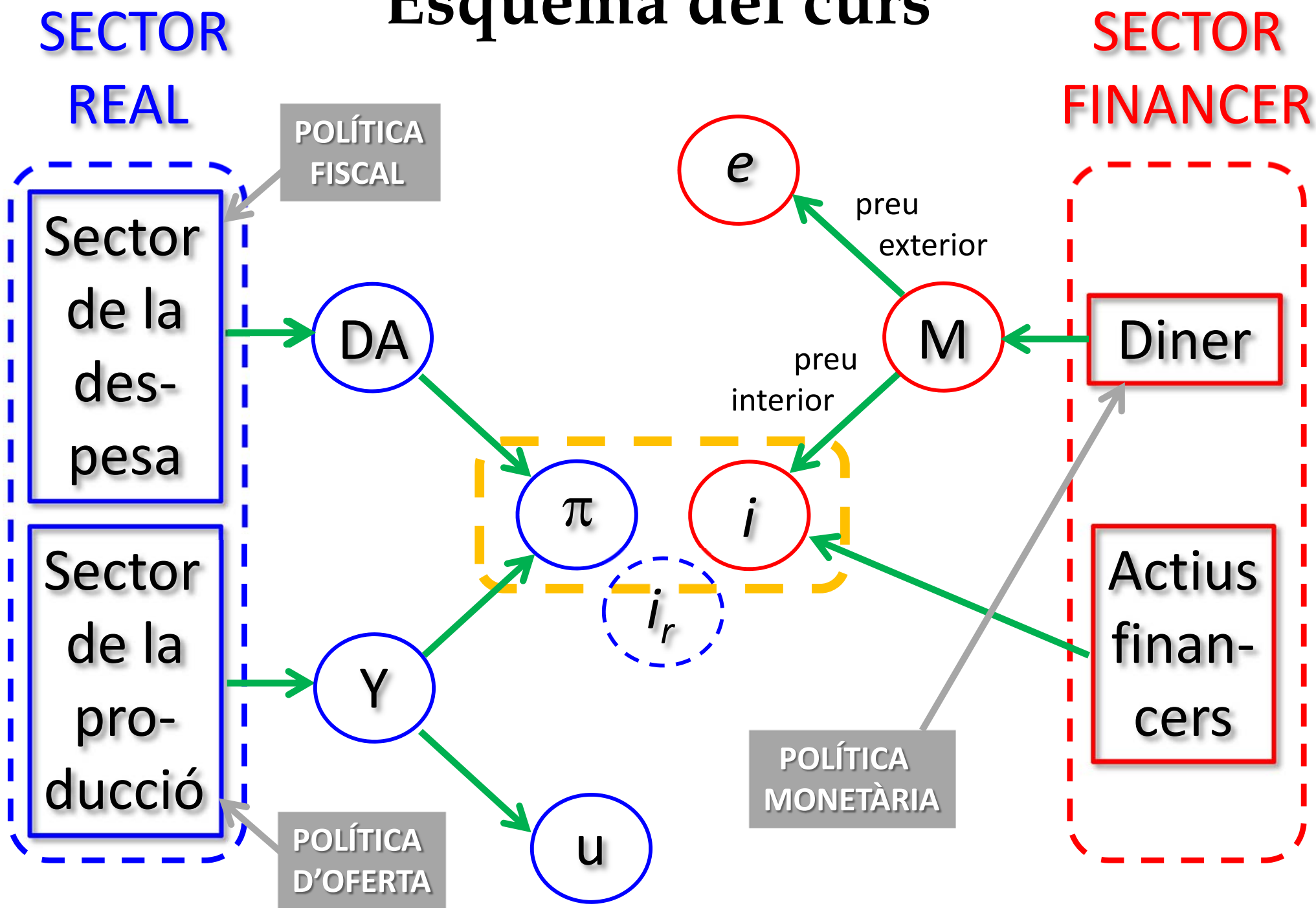

Esquema del curs

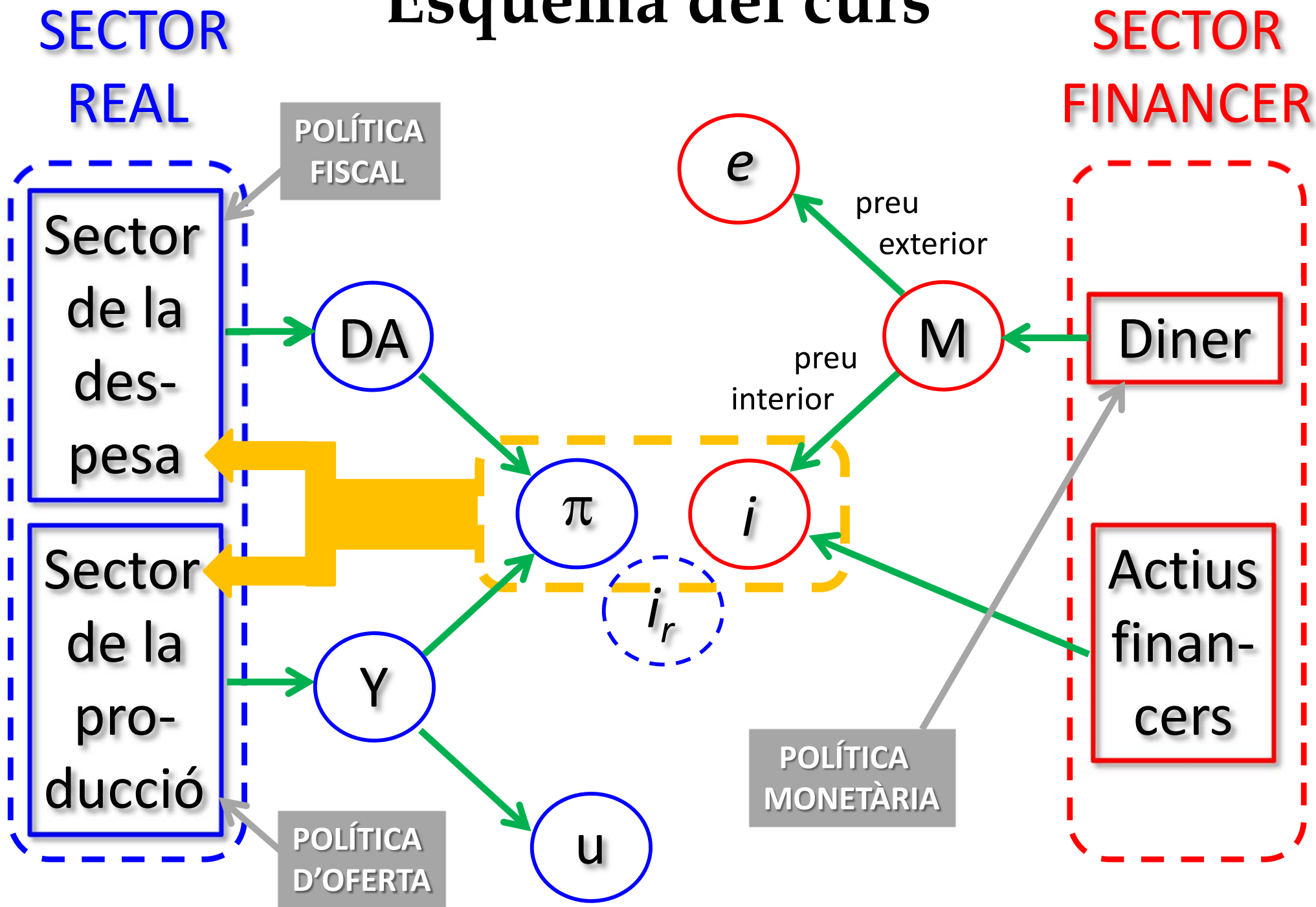

Esquema del curs

SECTOR
REAL

SECTOR
FINANCER

